

ONEPOLE Tophead - Zaptec Pro manual

ZM000788 - Pro Tophead Column Twin
 ZM000789 - Pro Tophead Column Single

ZM000790 - Pro Tophead Twin
 ZM000791 - Pro Tophead Single



Tophead

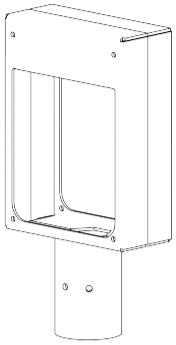

Zaptec Pro charger

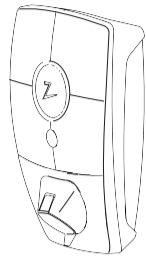

Mounting Bracket Pro

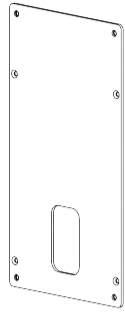

Blind plate (Premounted)
Single only



Column
Ø60x1340mm

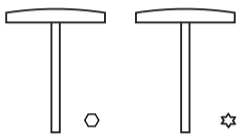

M8x10
Fastener bolts
Column only



M4x10
Mounting bracket bolts



M4x10
Blind plate bolts
Single only



M5x8
Mounting bolts
for Zaptec Pro



1 - ZM000788 - Pro Tophead Column Twin
 - ZM000789 - Pro Tophead Column Single

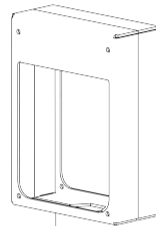

2 - ZM000788 - Pro Tophead Column Twin
 - ZM000789 - Pro Tophead Column Single

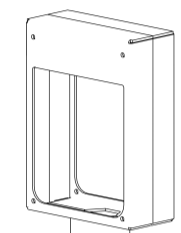

A 2pcs

1 - ZM000791 - Pro Tophead Single
 - ZM000789 - Pro Tophead Column Single

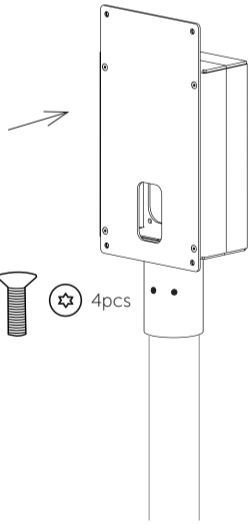

B 4pcs

2 - ZM000791 - Pro Tophead Single
 - ZM000789 - Pro Tophead Column Single

Check Zaptec Pro manual for mounting guide

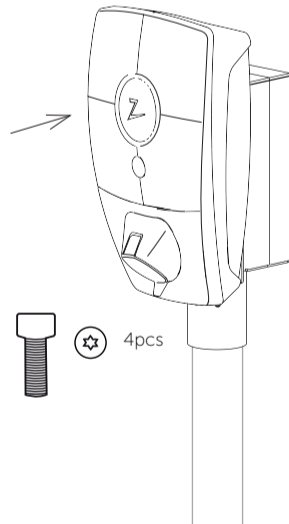

D 4pcs

3 - ZM000791 - Pro Tophead Single
 - ZM000789 - Pro Tophead Column Single

Blind plate is premounted.
Optional: Remove the blind lid to add additional charges

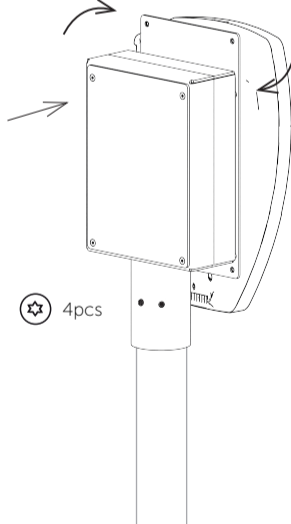

C 4pcs

ZM000791 - Pro Tophead Single
 ZM000789 - Pro Tophead Column Single

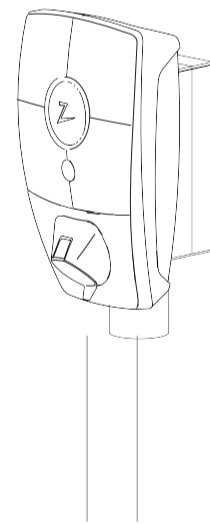

1 - ZM000790 - Pro Tophead Twin
 - ZM000788 - Pro Tophead Column Twin

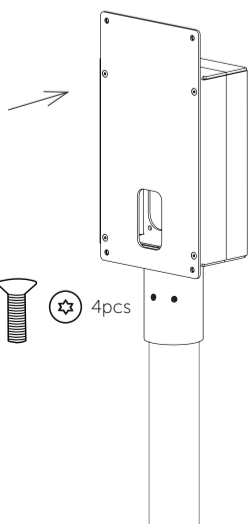

B 4pcs

2 - ZM000790 - Pro Tophead Twin
 - ZM000788 - Pro Tophead Column Twin

Check Zaptec Pro manual for mounting guide

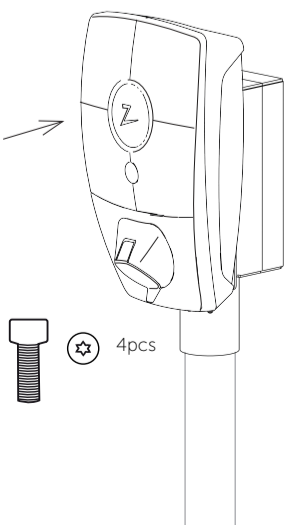

D 4pcs

3 - ZM000790 - Pro Tophead Twin
 - ZM000788 - Pro Tophead Column Twin

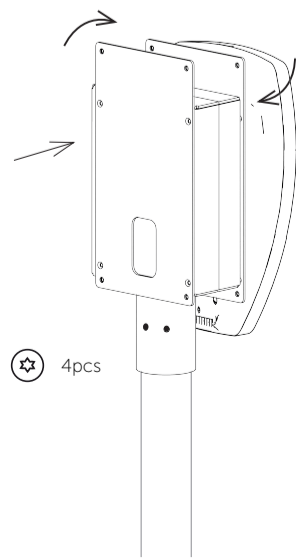

B 4pcs

4 - ZM000790 - Pro Tophead Twin
 - ZM000788 - Pro Tophead Column Twin

Check Zaptec Pro manual for mounting guide

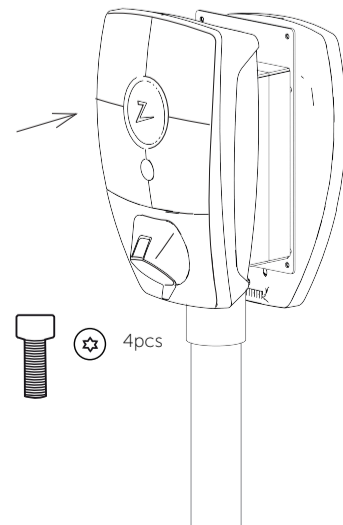

D 4pcs

ZM000790 - Pro Tophead Twin
 ZM000788 - Pro Tophead Column Twin

